



THE **SUPERIOR** CONTEMPORARY DOOR

---



# Simplicity.

## The ultimate form of sophistication.

Avantal is a range of ultra-modern doors designed to create a sleek and stylish entrance to your home.

Inspired by the smooth finish offered by industrial materials such as aluminium, the Avantal door has been engineered to offer a high-end look, whilst delivering a quality, solid construction and unrivalled levels of security.

Let our brochure be your source of inspiration, before heading over to our online Virtual Home Door Designer to create your unique Avantal design.

Proudly part of the Endurance Doors family.



### Avantal Range

Page 8



### Hardware & Glazing

Page 33

# Your door, your way.

Use our innovative Virtual Home Door Designer to view our range of door models, smooth finishes, glazing designs and hardware accessories on an actual photo of your own home.



# Why choose Avantal?

## YOUR DOOR, YOUR STYLE.

Style is a way to say who you are, without having to speak. At Endurance we believe that a home's exterior should leave a lasting impression, and each entranceway should reflect the character of who lives inside. That's why every Avantal door is completely unique, allowing you to choose from our range of sleek door models, smooth finishes, glazing designs and hardware accessories to create a truly individual design.

## SOLID, QUALITY CONSTRUCTION.

Unlike a typical entrance door, the Avantal design incorporates a truly solid, 48mm engineered timber core. The reassuring sound and feeling every time you close your Avantal door lets you know your house is both safe and secure.

Choose an Avantal door to protect your home and make would-be burglars think twice.

## SILKY SMOOTH FINISH.

Details make perfection, and perfection is not a detail. The smooth texture of an Avantal door and its powder coated, matte finish is what elevates the design beyond that of other door manufacturers. If you are dreaming of a sleek, contemporary look for your home's entrance, choose Avantal.

Rated excellent



on



At Endurance, we like to listen. We have learned a great deal by listening carefully.

In our 30 years of door manufacturing, listening to feedback has enabled us to develop a product and service offering that surpasses our customers' expectations. Time after time.

\*Rating accurate at the time of printing.

# What makes an Avantal door?

## 1 Hard Wearing Door Skin

Beauty is more than skin deep. The heat reflective properties and robust finish of the Avantal door skin ensure it will stand the test of time.

## 2 High Security Multi-Point Locking System

Our range of locking systems are tested to PAS 24 Security Standards.

## 3 Engineered 48mm Solid Timber Core

Our 45mm thick, cross laminated solid timber core makes the Avantal design the most solid and secure on the market.

## 4 High Security Locking Cylinder

Every Avantal door comes with the High Security, Diamond Grade ABS Ultimate locking cylinder, one of the most highly accredited locking cylinders in the UK.

## 5 Reinforced Door Frame

Our door frames are strong, secure and energy efficient. They are also perfectly colour matched to the rest of the door, something other manufacturers simply cannot achieve.

## 6 Thermally Toughened Glazing

Our range of contemporary glazing styles have been thermally toughened, offering the best in security whilst also looking chic.

## 7 Quality Hardware Accessories

Having been subject to rigorous testing for both finish and function, you can count on our range of stylish hardware accessories to stand the test of time.



PEACE OF MIND

# High security locking cylinder.



At Endurance, we believe everyone has the right to feel safe and secure in their own home. That's why every Avantal door is supplied with the innovative ABS Ultimate High Security Locking Cylinder, one of the most secure locking cylinders in the UK.

The ingenious locking system of the ABS Ultimate knows when it's being attacked. It has a hidden locking mechanism that automatically engages to stop would-be burglars in their tracks.

Lock snapping has become the preferred entry method for UK criminals and the ABS Ultimate Locking Cylinder has another trick up its sleeve to keep burglars at bay.

A sacrificial cut is used so that when the burglar grabs the end of the cylinder, just the tip snaps off, leaving more metal in front of the central locking mechanism as protection.

Having been tested to Sold Secure 'Diamond Grade' standards, the ABS Ultimate Locking Cylinder has achieved a level of security that far surpasses other locking cylinders on the market.



SNAP SECURE

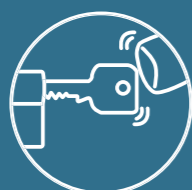

ANTI-BUMP



ANTI-DRILL



ANTI-PICK

# £2000 security guarantee.

We are so confident in the unprecedented level of security offered by the ABS Ultimate High Security Locking Cylinder used in our doors, that in the unfortunate event your home is broken into by means of snapping the cylinder, we will offer £2000 in compensation.

Terms & conditions apply. See website for full details.

# You're in safe hands.

We only select the most dedicated and talented installers to join our Installer Partner Network, so you can be sure your Avantal door will be installed to the highest possible standard. All of our Installer Partners have full access to not only the most stylish and secure doors in the UK, but to our knowledge and expertise, too.

With one of our Installer Partners, you can be sure of the best advice on choosing the right door for your home and the highest quality installation.

### Find your Local Installer Partner

Scan the QR code to discover your Local Installer Partner and request a quote for your dream Avantal door.



## AVANTAL INSTALLER PARTNER

To ensure that our Installer Partners reach our high standards, they must meet the following criteria:

- Have a track record of installing Avantal doors to our agreed fitting standard
- Have a clearly defined customer care policy that places the needs of the homeowner first
- Have clearly defined policies for monitoring service levels and handling complaints
- Have an excellent knowledge our products and take part in specialist training.

\*Map is for illustration purposes only. Not accurate to location of installers.

# The Avantal Door Range.

Our collection of door models, finishes, glazing designs and hardware accessories have been exclusively curated to assemble a range that offers the best in contemporary, sleek design. Begin by selecting your ideal door model and colour, before exploring our range of modern glazing styles and hardware accessories to create an Avantal door that truly showcases your unique style.

Create your unique Avantal design by scanning this QR code on your smartphone, or head to [avantaldors.co.uk](http://avantaldors.co.uk)

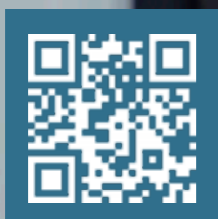

## Finishes to suit your style.

Avantal doors are available in a range of ultra-modern monochrome and realistic woodgrain finishes, allowing you to achieve a contemporary, high-end finish for your home's entrance.

Select from our range of ultra-smooth monochrome finishes to create a sleek, colour matched design across the door leaf, frame and glazing cassettes or opt for one of our woodgrains finishes with contrasting features to really make a style statement.

All Avantal doors are manufactured with a Crystal White internal side, allowing you to create a light and airy entranceway for your home.

**Avantal skin swatches are available on request.**



AnTeak

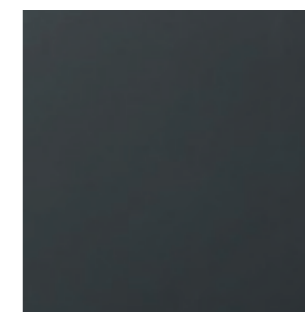

Anthracite Grey

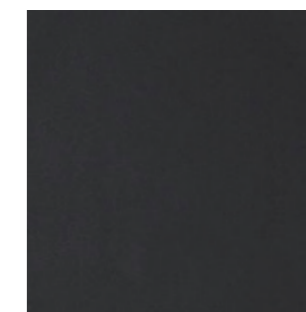

Black Ulti-Matt



Signal Grey

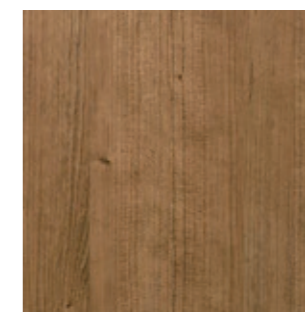

Rustic Cherry

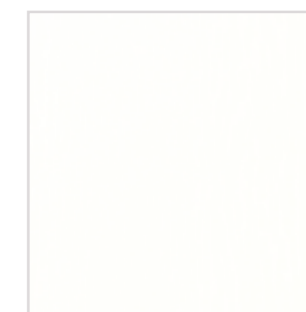

Crystal White\*

COLOUR	Door Leaf	Door Frame	Glazing Cassette
AnTeak	✓	✗	✗
Anthracite Grey	✓	✓	✓
Black Ulti-Matt	✓	✓	✓
Rustic Cherry	✓	✗	✗
Signal Grey	✓	✓	✓

\*All Avantal doors are supplied with a Crystal White internal finish across the door leaf, frame and glazing cassettes. Crystal White is available on the internal side only.

# Antares

## Beauty in simplicity.

With a combination of the ultra-smooth Anthracite Grey skin and a bold 1200mm pull bar handle, this design offers an eye-catching, yet understated contemporary aesthetic.

## Creating contrast.

Choose Black Ulti-Matt or Anthracite Grey along with our range of stainless steel hardware accessories to add a sense of drama to your Antares design.

## Let the light in.

The most popular design within the Avant collection, the Antares features a well proportioned glazed area that allows light to fill your entranceway.

## Your door, your style.

Design your dream Antares door on our Virtual Home Door Designer. Experiment with our range of finishes, glazing styles and hardware accessories whilst viewing your designs on a photo of your own home.

Anthracite Grey

Scan here  
to experience  
**Antares**



**GET THE LOOK**

**Door style**

Antares.

**Door colour**

Black Ulti-Matt.

**Frame colour**

Anthracite.

**Glass**

Virtue.

**Hardware**

Premium.

---

**Scan** below to  
view Helene's  
door in detail.



# Antares



AnTeak



Signal Grey



Rustic Cherry



Black Ulti-Matt





# Celeste



AnTeak

## Modern luxe.

Combined with a statement premium letterplate and a striking pull bar handle, this design offers a bold, modern look.

## Fusion of tones.

Choose contrasting cassette colours to make a real statement. Choose from our range of stainless steel hardware accessories to add a touch of class to your Celeste design.

## Contemporary flair.

Celeste features a minimal but well proportioned glazing area that allows light into your entranceway, but also maintains privacy.

## Your door, your style.

Design your dream Celeste door on our Virtual Home Door Designer. Experiment with our range of finishes, glazing styles and hardware accessories whilst viewing your designs on a photo of your own home.



AnTeak



Scan here  
to experience  
**Celeste**



# Celeste



External View



Internal View



Rustic Cherry



Anthracite Grey



Black Ulti-Matt

## Virtual Home Designer

Use our innovative Virtual Home Door Designer to try our range of door styles, colours, glazing and hardware accessories on a photo of your own home.

Try Virtual Home now by scanning this QR code on your smartphone, or head to [avantaldoors.co.uk](http://avantaldoors.co.uk)

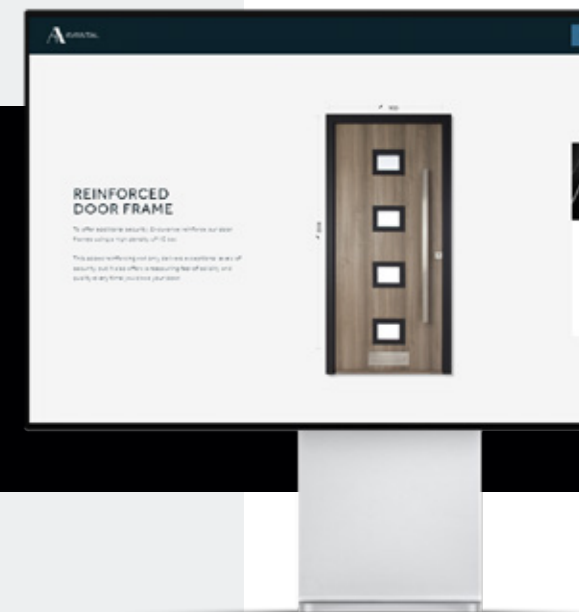

### REINFORCED DOOR FRAME

To offer superior security, Celeste offers our door Reinforced Door Frame for models of 10 and 12.

This option will bring you an extra level of security and is available on all models of 10 and 12. It is not available on our 14 model.

# Rigel



Signal Grey

## Grand designs.

A smooth Signal Grey skin, with matching glazing cassettes, provide this design with an aluminium look, perfect for the most contemporary entranceway.

## A fresh take on style.

Choose Signal Grey or Anthracite along with our range of stainless steel hardware accessories to add a sense of drama to your Rigel design.

## Urban appeal.

Whether you choose matching or contrasting cassette colours, this cool, modern style adds simplistic urban charm to even the most modern home.

## Privacy. Security. Style.

If you're looking to create a private entranceway but still let in some natural light, the Rigel offers the best of both worlds. Choose Satin glass to fully obscure the inside of your home from the outside world.



Signal Grey



Scan here  
to experience  
**Rigel**





AnTeak



Anthracite Grey



Rustic Cherry



Black Ulti-Matt

# Rigel



External View



Internal View

## Virtual Home Designer

Design your own dream Avantal door using our exciting Virtual Home Door Designer. You can even view your completed design on a photograph of your own home.

[avantaldoors.co.uk](http://avantaldoors.co.uk)

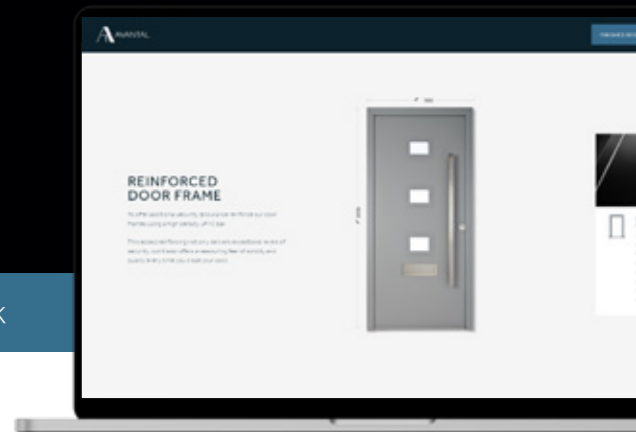

# Sirius



Rustic Cherry

## Minimalistic style.

Sometimes, less is more. To create an understated entrance that exudes sophistication, choose the Sirius design along with our range of stainless steel hardware accessories.

## Accessorize your entrance.

Elevate your Sirius door design by adding a quality, solid door knocker and striking plate from our range of Premium hardware accessories.

## Versatile looks.

By opting for Black Ulti-Matt or Anthracite Grey, along with a perfectly colour matched frame, the Sirius design can be used to create an ultra-minimalistic look for your home. Alternatively, go bold with a Rustic Cherry door leaf and contrasting Black Ulti-Matt frame.

## Solid. Secure. Private.

Totally Solid. For maximum security and privacy, choose the Sirius to protect your home



Rustic Cherry

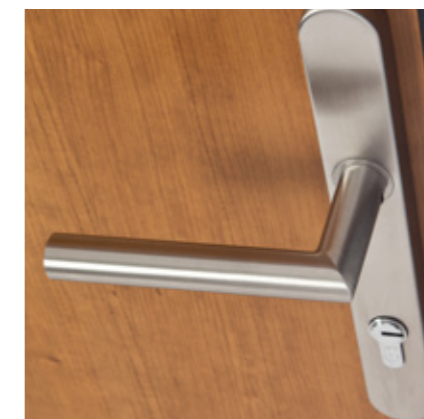

Scan here  
to experience  
**Sirius**



# Sirius



External View



Internal View



AnTeak



Anthracite Grey



Black Ultra-Matt

## Virtual Home Designer

Use our innovative Virtual Home Door Designer to try our range of door styles, colours, glazing and hardware accessories on a photo of your own home.

Try Virtual Home now by scanning this QR code on your smartphone, or head to [avantaldoors.co.uk](http://avantaldoors.co.uk)

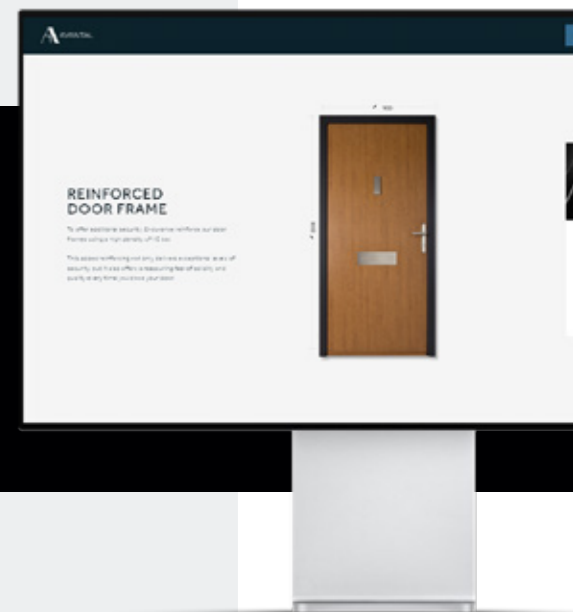

### REINFORCED DOOR FRAME

To offer superior security, Enclosure offers our door frames with a reinforced frame.

This offers additional security, strength and stability to your door.

# Vega

## Statement looks.

The large glazing area combined with a long premium pull bar handle gives the Vega design a striking appearance, creating a statement entranceway for your home.

## Versatile style.

Experimenting with different glazing styles on the Vega allows you to achieve very different looks. Choose from Clear or Satin glazing to deliver a minimal aesthetic or opt for Simplicity to add extra detail and texture to your design.

## Bringing the outdoors in.

If you're looking to create a seamless link between indoor and outdoor space, or create a light and airy hallway, the large, glazed area of the Vega, coupled with Clear glazing is the ideal solution.

## Reimagine your hallway.

Did you know that you can view the internal side of your chosen Avantal door on a photograph of the inside of your hallway using our innovative Virtual Home Door Designer?

Black Ulti-Matt



Scan here  
to experience  
**Vega**



## GET THE LOOK

### Door style

Vega.

### Door colour

Anthracite.

### Glass

Clear.

### Hardware

Premium.

---

## DESIGN YOUR DOOR

Use our innovative Virtual Home Door Designer to try our range of door styles, colours, glazing and hardware accessories on a photo of your own home.

Try Virtual Home now by scanning this QR code or head to [avantaldors.co.uk](http://avantaldors.co.uk)





# Vega



AnTeak



Anthracite Grey



Rustic Cherry



Signal Grey



# Hardware.

Even though they are the last things to be fitted to an Avantal door, glazing and hardware accessories are certainly the elements that draw the most attention.

Whether you're looking for an airy entrance way, filled with natural light or a more private option, with simple style, our range of glazing designs can deliver on your vision.

When adding the finishing touches to your Avantal door, our range of high quality hardware options, from ultra-modern square stainless steel pull bars to our simple lever handles, combine the very best in both form and function.

## Standard Hardware Range.

Designed to offer a sleek, modern look, the standard range of Avantal hardware features rounded details and smooth curves.

Having been subject to rigorous testing for both finish and function, the standard range of Avantal hardware comes complete with a comprehensive 10-year warranty.



10 year warranty on all standard hardware



Round stainless steel pull bar handles are available in the following lengths: 400mm, 900mm, 1200mm & 1800mm

### Handles

Our range of standard handles includes a choice of stylish lever handles, a robust fixed pull knob and a round pull bar handle.



Standard stainless steel pull knob



Standard stainless steel lever handle



Graphite architectural lever handle

### Knockers

These contemporary door knockers have been designed to suit a high-end entranceway, adding a look of sophistication to your chosen Avantal design.



Standard stainless steel knocker



Graphite architectural knocker

### Letterplates

The sleek design of our standard letterplates allow you to make a style statement with what is typically mainly a functional feature.



Standard stainless steel letterplate



Graphite architectural letterplate

\*Graphite Hardware from our architectural range is not perfectly colour matched to our range of stainless steel accessories

NEW FOR 2023

# Premium Black Hardware.

Designed to enhance the modern, industrial aesthetic of our Avantal range, our Premium Black hardware is the pinnacle of contemporary style.

Hardwearing and beautifully smooth to the touch, this premium coated product is guaranteed to last the test of time and daily use of a large family. Created from 316 marine grade stainless steel and powder coated, these pieces exude quality construction.

If you would like your hardware to complement your black, flush fitting cassettes on the Avantal door, this brand new and innovative hardware is the perfect choice.



Lifetime warranty on all premium hardware

## Handles

The Premium Black handle range features a wide range of solid and secure options for your Avantal door, including a modern square pull bar handle and a more traditional lever alternative.

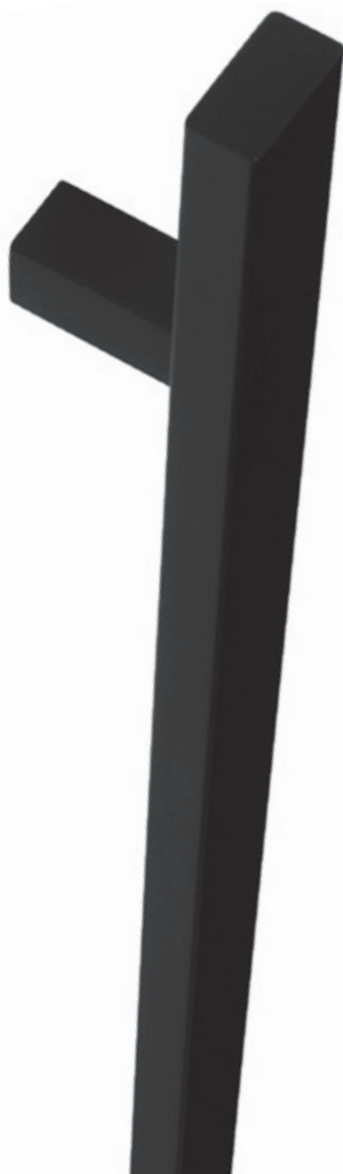

**Premium Black**  
Stainless steel square pull handle - Available in 900mm & 1200mm



**Premium Black**  
Stainless steel round pull knob

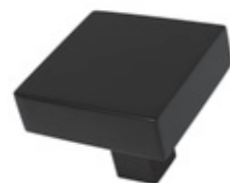

**Premium Black**  
Stainless steel square pull knob



**Premium Black**  
Stainless steel lever handle

## Knockers

The Premium Black knocker feels, looks and sounds substantial. The minimal style sits perfectly with the Avantal range.



**Premium Black**  
Stainless steel knocker

## Letterplate

Classic and practical, this letterplate will enhance any of the Avantal designs. The clean design conveys style and the built-in security flap will provide you with peace of mind.



**Premium Black**  
Stainless steel letterplate

Front

Back



# Premium Hardware.

We have curated a collection of perfectly matching, stainless steel, Premium Hardware accessories that will enhance the aesthetics of any of the ultra-contemporary doors in the Avantal range.

When handling any of the accessories within our range of premium hardware, you will be struck by their quality, weight, construction, and luxurious finish.

Made from 316 marine grade stainless steel, our range of premium hardware accessories come complete with Lifetime Guarantee against both finish and function, across the entire range.



## Handles

Our range of premium handles includes a sleek lever handle, both round and square internal pull knobs and an ultra-stylish square pull bar handle and escutcheon.

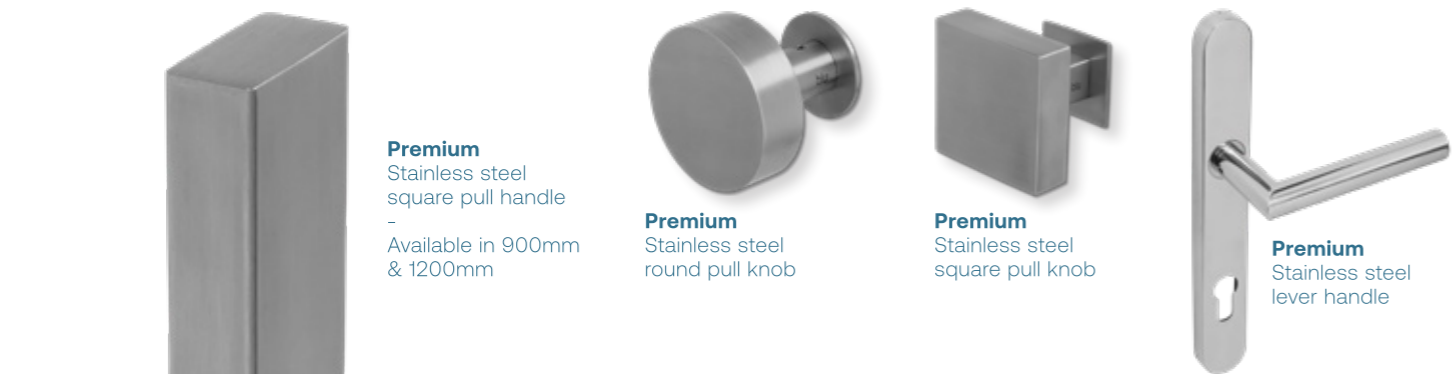

**Premium**  
Stainless steel square pull handle - Available in 900mm & 1200mm

**Premium**  
Stainless steel round pull knob

**Premium**  
Stainless steel square pull knob

**Premium**  
Stainless steel lever handle

## Knockers

Heavy, solid, and stylish. Our premium door knocker perfectly complements the hefty robust construction of the Avantal design.



**Premium**  
Stainless steel knocker

## Letterplate

The clean lines and simple design of our premium letterplate make it the ideal accessory to complete your dream Avantal design. A built-in inner security flap ensures that this design is both secure as well as stylish.

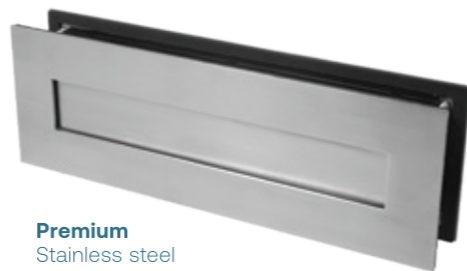

**Premium**  
Stainless steel letterplate

## THE UK'S MOST Solid & secure door.

### TRULOCK +

A modern-day locking system with two tensile steel hooks and a centrally located deadbolt. Ideally suited to doors with lever handles. Lift the handle to engage the locking mechanism and lock with a key.

### AV2 AUTOMATIC LOCK

This locking mechanism automatically locks once the door is slammed shut, with firing pins engaging the two tensile steel hooks. The deadbolt is then activated by turning the key. The door can be opened internally using a thumb turn cylinder but remains completely secure from the outside. Ideal for doors with fixed external handles. Once locked, entry from outside is gained by use of a key.

### AV3 AUTOMATIC LOCK

The AV3 locking mechanism has a magnetic trigger in its frame that causes two tensile steel hooks and two separate weather sealing elements to fire automatically once the door is slammed shut. An optional daytime release function can be activated to temporarily stop the door from automatically locking once closed. Ideal for doors with fixed external handles. Once locked, entry from outside is gained by use of a key.

**NEW**

### ERA 4 HOOK

New for 2023, we are offering the security focussed ERA 4 Hook locking system with central deadbolt and handle lift engagement. This features four opposing steel hooks for additional peace of mind.

# Glazing styles.

Whether you're looking to create a light and airy hallway or a private entrance, our selection of glazing designs makes it easy to achieve your desired look and feel.

All our glass designs have been thermally toughened, resulting in a glazing range which is strong, secure and stylish.

## Clear

Fill your hallway with light and bring the views from the outdoors into your home by choosing Clear glazing.

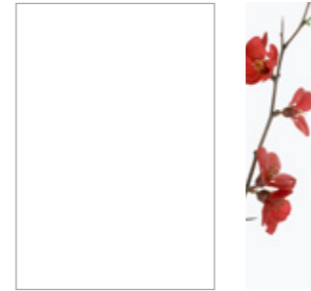

Opacity



## Satin

Fill your home with natural light whilst still maintaining your privacy by choosing Satin.



Opacity



## Simplicity

Clean, simplistic design combined with bevels and textured glass. Make a feature of your glazing by choosing Simplicity.



Opacity



## Virtue

A twist on a classic Satin glass design, Virtue has a clear etched border, adding to the beautiful simplicity of this style.



Opacity

\*Not available in Rigel or Celeste door styles





ADD A SENSE OF GRANDEUR TO YOUR HOME

# Sidelights & Toplights.

If you are looking to fill your home with natural light, our range of sidelight and toplight configurations are the perfect solution.

Just like every Avantal door design, our sidelights and toplights are made bespoke to meet your exact requirements, including your choice of configuration, measurements, colour and glass.

By combining your chosen Avantal door design with our range of sidelight and toplight configurations, you can elevate the look of your home and fill your hallway with natural light.

Ideal for linking inside and outside space, glazed side panels and toplights can be used to make the space around your entrance feel much larger and more impressive.

To view our full range of sidelight and toplight configurations, try our fabulous Virtual Home Door Designer. You can even take a photograph of your own home and hallway to create a realistic vision for your completed project.

[avantaldors.co.uk](http://avantaldors.co.uk)



Single Toplight



Flag Sidelight



Single Full Height Sidelight



Double Full Height Sidelights



# Threshold options.

We offer a threshold to suit every homeowner. The MDS25 and Macclex Aluminium Thresholds are both Part M Compliant and meet the latest regulations for Building Regulations for Easy Access.

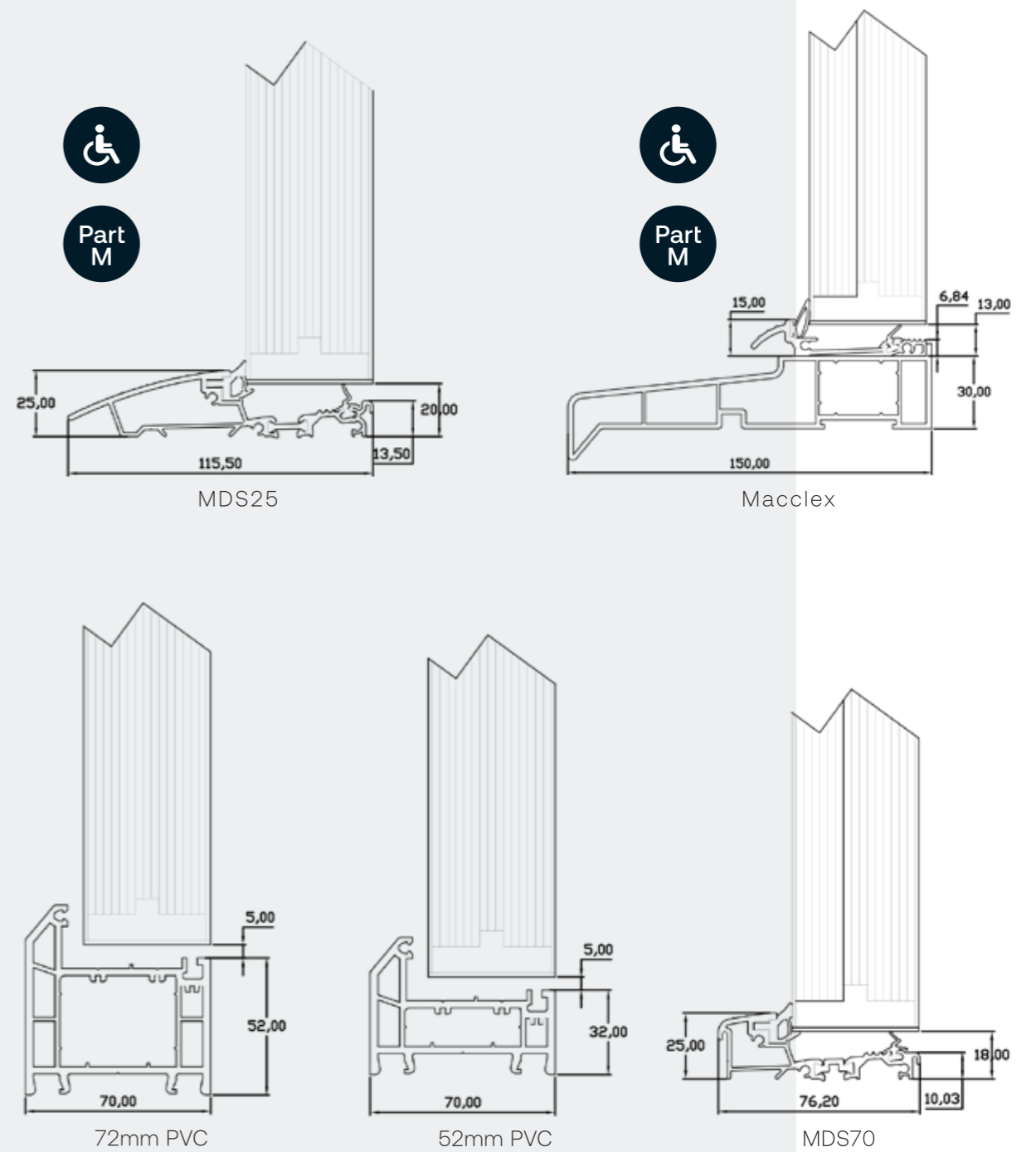

Rated  
excellent



on

 Trustpilot

\*Rating accurate at the time of printing.

# Your door, your way.

To view our full range of doors try our Virtual Home Door Designer. Take a photograph of your own home and hallway to create a realistic vision for your completed project.

Try our Virtual Home Door Designer by scanning the QR code below or head to [avantaldors.co.uk](https://avantaldors.co.uk)







[avantaldors.co.uk](http://avantaldors.co.uk)

All colours and images are a visual representation only. We recommend you request to see colour samples from your chosen Installer Partner. Slight variations in colours and finish may occur due to the handcrafted nature of the product or the limitations of the printing process. As it is company policy to improve products and materials, changes to specification may be made from time to time without prior notice.  
Dec2022/VERSION2